

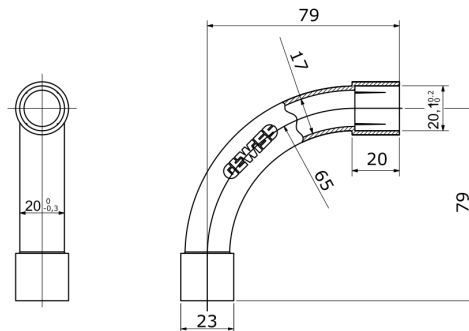

Routing components for rigid protective conduits with IP40 and IP67 protection degree.

Colour	Grey RAL 7035	IP degree	IP40
Conduits Ø (mm)	20	Type of material	Halogen-free in compliance with EN 50267-2-2
Electrocod	21221		

DIMENSIONAL



TECHNICAL SYMBOLOGY

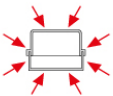

IP40

STANDARDS/APPROVALS



GEWISS S.p.A. Via A. Volta, 1
24069 Cenate Sotto - Bergamo - Italy
tel. +39 035 94 61 11 fax +39 035 94 69 09

www.gewiss.com
sat@gewiss.com
Last update 26/05/2016

Data, measures, designs and pictures are shown only as informativ purposes, and could be changed without previous notice