

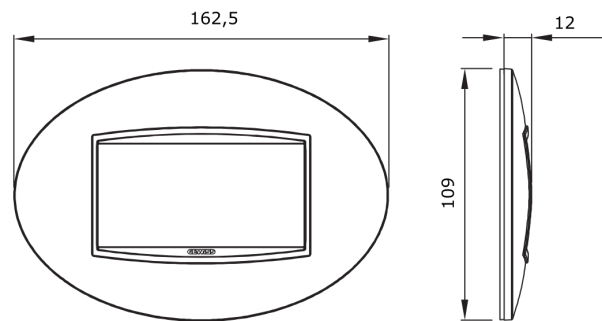

Range of plates for the Chorus wiring devices, made in a wide choice of shapes, colours, materials and finishes. It includes six different shapes (ONE, GEO, LUX, FLAT, ART and ICE) for rectangular boxes up to 12 modules and three different shapes (ONE International, GEO International and LUX International) suitable for round/square boxes, in single or multiple horizontal/vertical modularity, from 2 up to 2+2+2+2 modules. All the plates in the Chorus wiring devices use the same frame supports, without the necessity of additional adapters. The range includes also blank plates, IP55 waterproof plates and self-supporting plates for profiles and panels.

Family	ART	Colour	Ice
Material	Glass	Finishing	Opaque finish
Description	4 gang	For support codes	GW16804
Standard	EN 60669-1		

DIMENSIONAL



TECHNICAL SYMBOLOGY STANDARDS/APPROVALS



GEWISS S.p.A. Via A. Volta, 1
24069 Cenate Sotto - Bergamo - Italy
tel. +39 035 94 61 11 fax +39 035 94 69 09

www.gewiss.com
sat@gewiss.com
Last update 01/07/2016

Data, measures, designs and pictures are shown only as informativ purposes, and could be changed without previous notice