

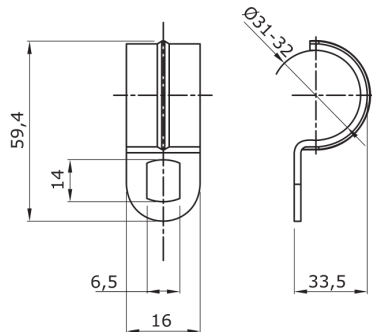

Systems of accessories for electrical installations used for residential, tertiary and industrial applications. The system consists of fasteners for pipes and cables, cable fittings, accessories for rigid pipes (RK Series) and flexible conduit (DF Series). The system include also a wide variety of cable ties (52FS Range) and terminal blocks (44 Range).

Material	Galvanised steel	Internal Ø (mm)	31.0 - 32.0
Hole dimension (mm)	14x6	Description	Clip
For external conduits (mm)	31-32	Type	With one hole
Electrocod	21211		

DIMENSIONAL



TECHNICAL SYMBOLOGY STANDARDS/APPROVALS

GEWISS S.p.A. Via A. Volta, 1
24069 Cenate Sotto - Bergamo - Italy
tel. +39 035 94 61 11 fax +39 035 94 69 09

www.gewiss.com
sat@gewiss.com
Last update 26/05/2016

Data, measures, designs and pictures are shown only as informativ purposes, and could be changed without previous notice