

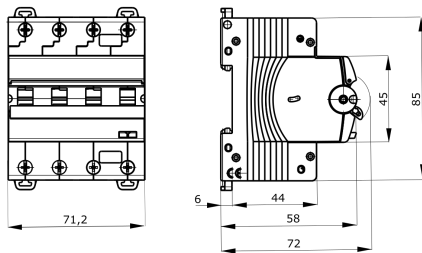

Description	RCCB WITH OVERCURRENT PROTECTION
Code	MDC 45
No. of poles	4P
No. modules	4
Rated current	25 A
Rated residual operating current	30 mA
Type	AC
Curve	C
Rated voltage	400 V

Standard	EN 61009-1	Rated frequency (Hz)	50Hz
Breaking capacity EN 61009-1 400V (Icn)	4.500 A	Breaking capacity EN 61009-1 (Ics)	1 x Icn
Breaking capacity EN 60947-2 400V (Icu)	4,5 kA	Breaking capacity EN 60947-2 (Ics)	100% Icu
Insulation voltage	500 V	Level of immunity (8/20 s)	250 A
Electrical endurance	10.000	Mechanical endurance	20.000
Section rigid cable	Max 35 mm ²	Section flexible cable	Max 35 mm ²
Rated tightening torque	2 Nm	Operating temperature	-25 +40 °C
Stocking temperature	-40 +70 °C	Electrocod	1413

DIMENSIONAL



SCHEMA ELETTRICO

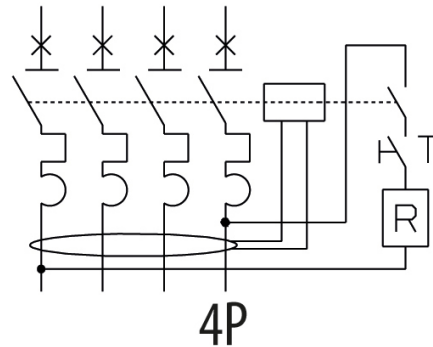

STANDARDS/APPROVALS

